

7 (5)+6+

- x2
- x2

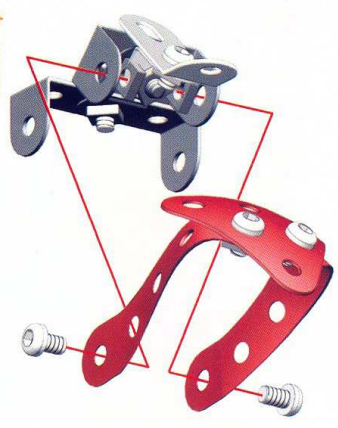

1

- x1
- x1
- x1
- x1
- x1



8 (7)+4+

- x1
- x1
- x1

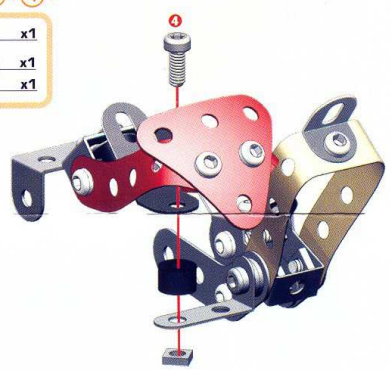

2

- x1
- x2
- x2

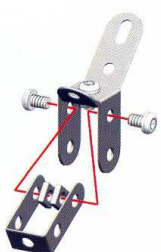

9

- x1
- x1
- x2
- x2

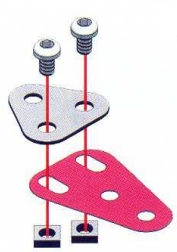

3 (2)+

- x1
- x1
- x1
- x3
- x3

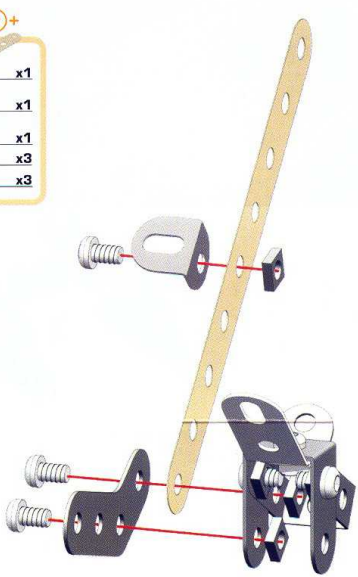

10

- x1
- x1
- x1
- x1
- x1

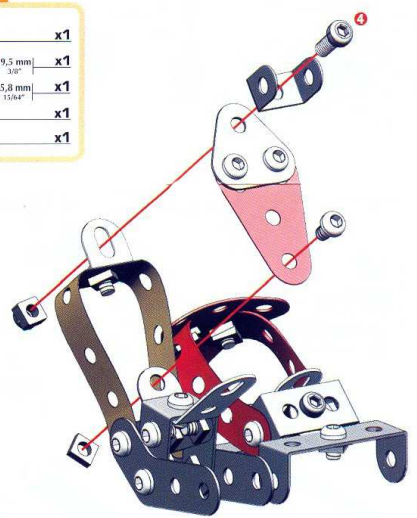

4

- x1
- x1
- x1
- x2
- x1
- x2

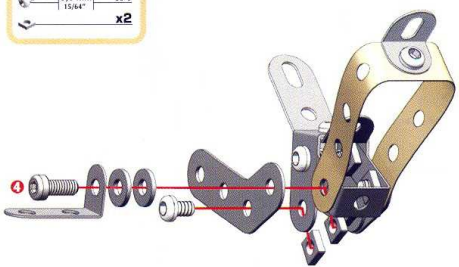

11

- x2
- x2
- x4
- x4

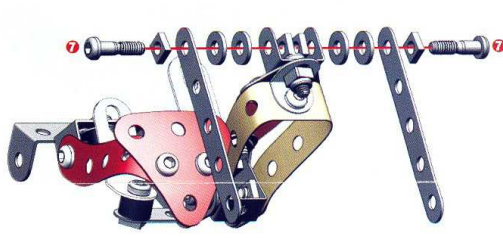

5

- x1
- x1
- x1
- x1
- x1
- x1
- x1
- x2
- x3

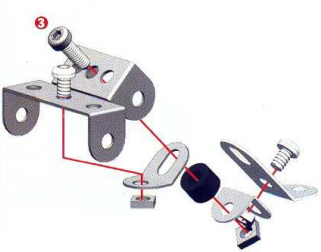

6

- x2
- x1
- x2
- x2



12

- x1
- x1
- x3
- x3
- x1
- x4

