









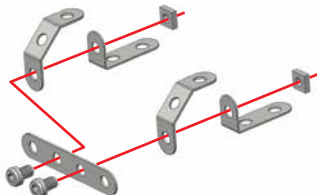

1

	S1 5.8 mm 15/64"	x2
		x2
		x2
		x1

	S1	1:1
---	----	-----



2

	S3 12 mm 1/2"	x2
		x2
		x2

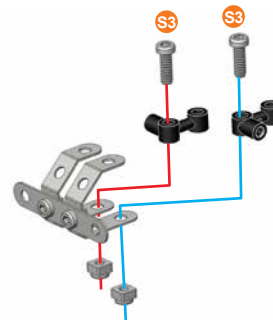
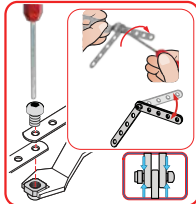

	S3	1:1
---	----	-----



3





	x1
	x2
	x2

**4**

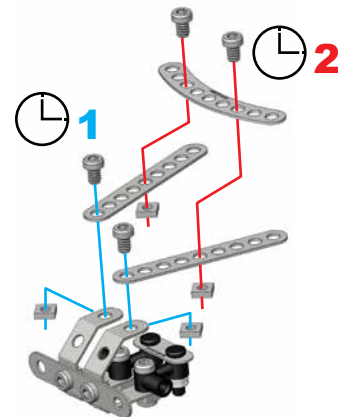
	x4
5.8 mm	x4
15/64"	
	x1
	x2



	1:1
---	------------

**5**

	x2
5.8 mm	x2
15/64"	
	x2
	x2
	x1

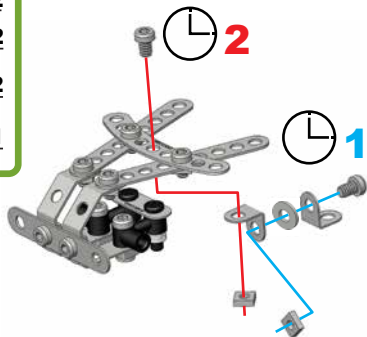
	1:1
---	------------





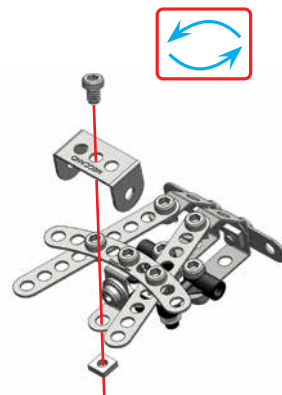

**6**

	x1
5.8 mm	x1
15/64"	
	x1

	1:1
---	------------





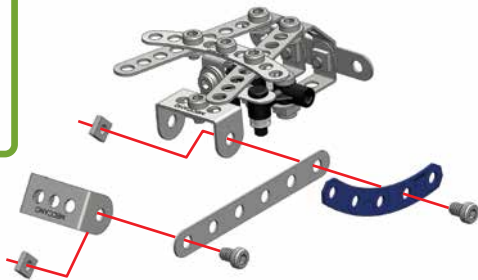

7

-  **S1** | 5.8 mm | **x2**
15/64"
-  **x2**
-  **x1**
-  **x1**
-  **x1**
-  **x1**

-  **S1** | **1:1**







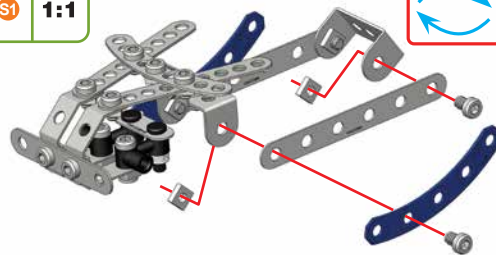

8





-  **S1** | 5.8 mm | **x2**
15/64"
-  **x2**
-  **x1**
-  **x1**
-  **x1**

-  **S1** | **1:1**





9

-  **S2** | 9.5 mm | **x1**
3/8"
-  **B1** | 14.7 mm | **x1**
37/64"
-  **x2**
-  **x3**
-  **x1**
-  **x1**

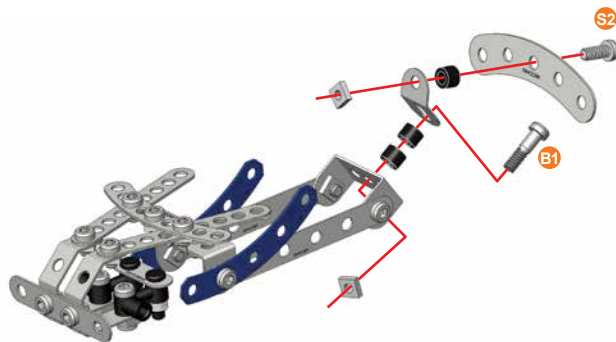
-  **B1**
-  **S2**
-  **A338**
- 
- 1:1**





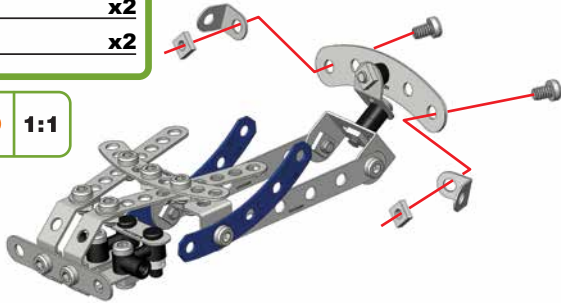

10

-  5.8 mm | 15/64" | **x2**
-  **x2**
-  **x2**

-  **S1** | **1:1**





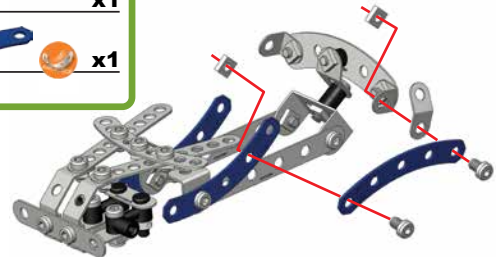

11

-  5.8 mm | 15/64" | **x2**
-  **x2**
-  **x1**
-  **x1**

-  **S1** | **1:1**





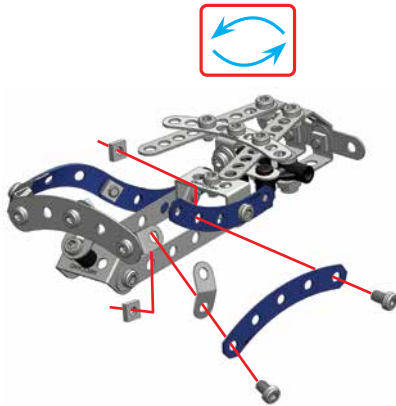

12

-  5.8 mm | 15/64" | **x2**
-  **x2**
-  **x1**
-  **x1**

-  **S1** | **1:1**





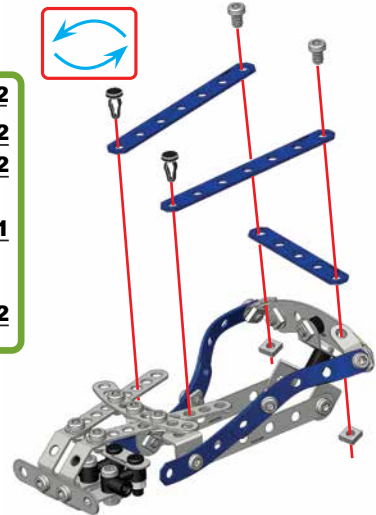

13

-  5.8 mm | 15/64" | **x2**
-  **x2**
-  **x2**
-  **x1**
-  **x2**

-  **S1** | **1:1**





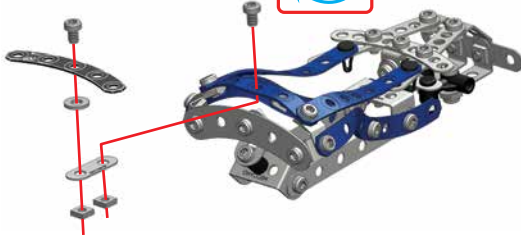

14

-  5.8 mm | 15/64" | **x2**
-  **x1**
-  **x2**
-  **x1**
-  **x1**





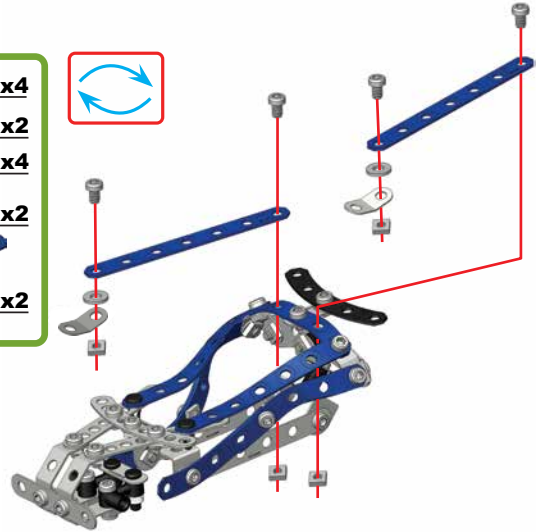

15

-  5.8 mm | 15/64" | **x4**
-  **x2**
-  **x4**
-  **x2**
-  **x2**



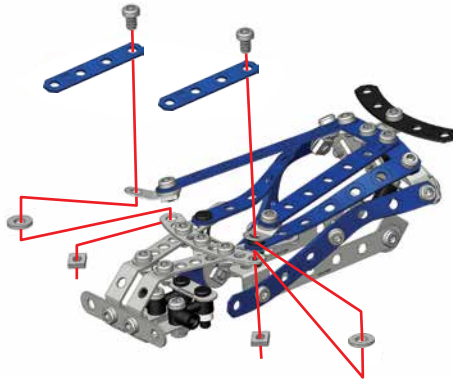

16

-  5.8 mm | 15/64" | **x2**
-  **x2**
-  **x2**
-  **x2**
-  **x2**



17

-  5.8 mm | 15/64" | **x2**
-  **x2**
-  **x1**

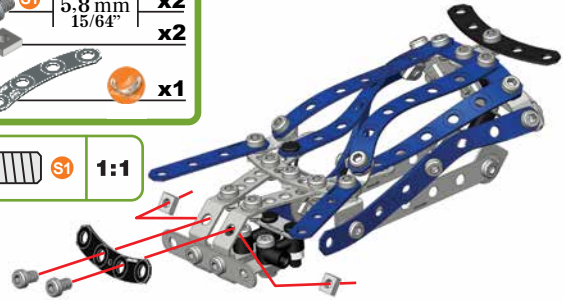

18

S1 | 5.8 mm | x2
15/64" | x2

S1 | 1:1

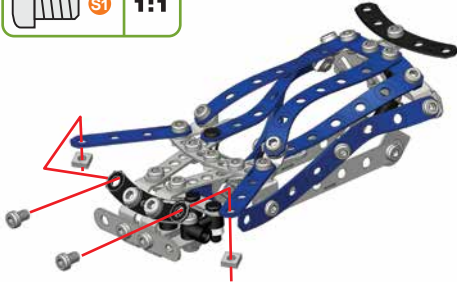

19

x1
S1 | 5.8 mm | x2
15/64" | x2

S1 | 1:1

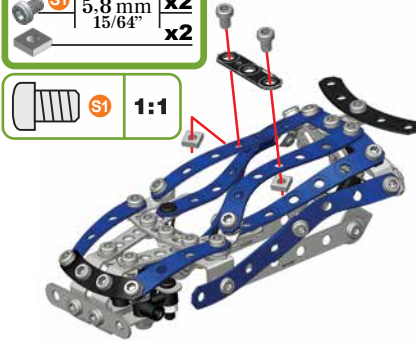

20

x4

x4

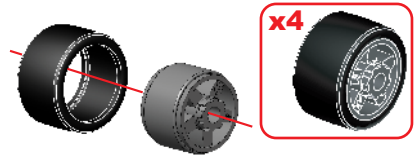

x4

A338 | 1:1

21

(19)+(20)+

x2
x2

x1
63.5 mm |
2 17/32"

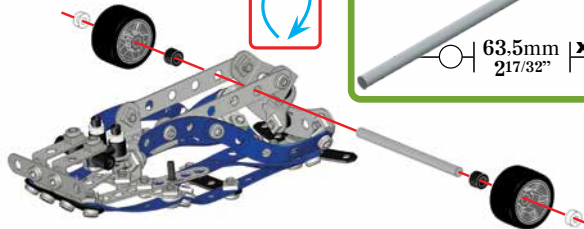

1:1

22

(20)+(21)+

B2 | 19 mm | x2
3/4"

B2 | 1:1

