











#1512

1

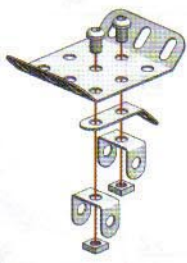
-   x1
-  x2
-  x1
-  x2
-  | 5,8 mm | x2



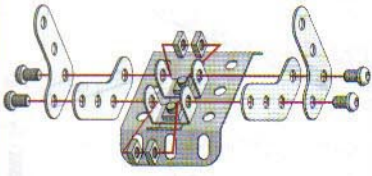

2

-  x2
-  x2
-  x4
-  | 5,8 mm | x4



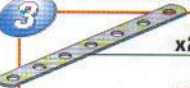

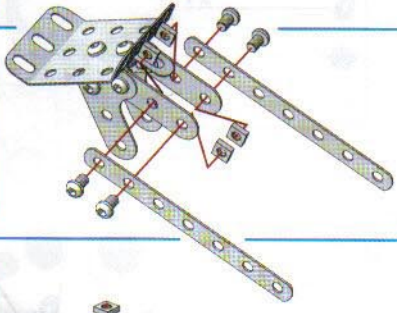

3

-  x2
-  x4
-  | 5,8 mm | x4





4

-  x1
-  x1
-  x1
-  | 5,8 mm | x1





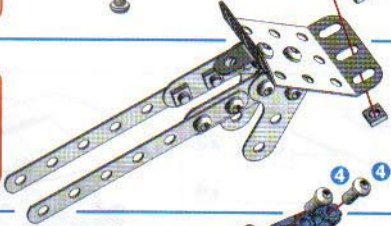

5

-  x1
-  | 5,8 mm | x1



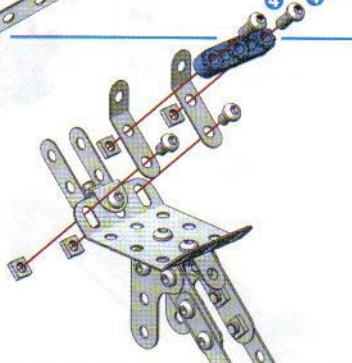

6

-  x1
-  x2
-  x4
-  | 9,5 mm | x2
-  | 5,8 mm | x2



7



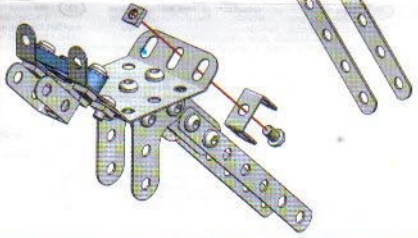

-  x1
-  x1
-  | 5,8 mm | x1



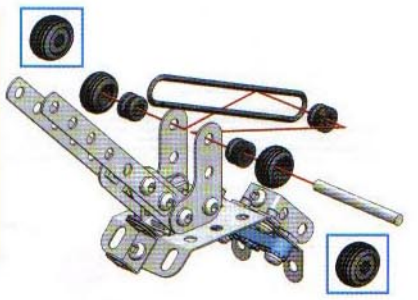



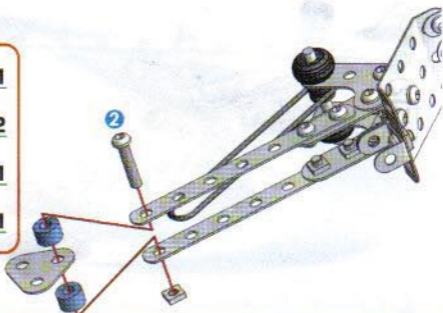

8

-  x1
-  | 40 mm | x1
-  x2
-  x3







- 9**
-  x1
 -  x2
 -  x1
 -  19 mm | 3/4" x1

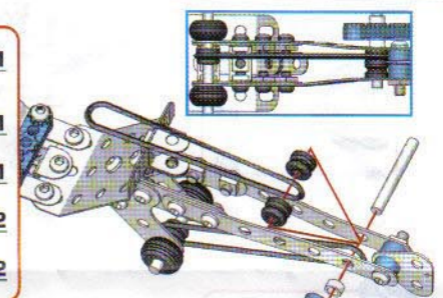

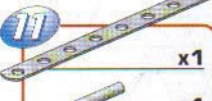
- 10**
-  x1
 -  32 mm | 1 1/4" x1
 -  x1
 -  x2
 -  x2



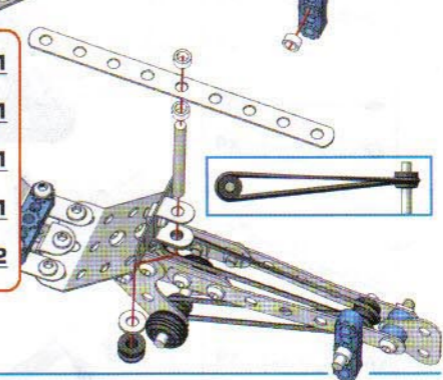

- 11**
-  x1
 -  40 mm | 1 1/2" x1
 -  x1
 -  x1
 -  x2

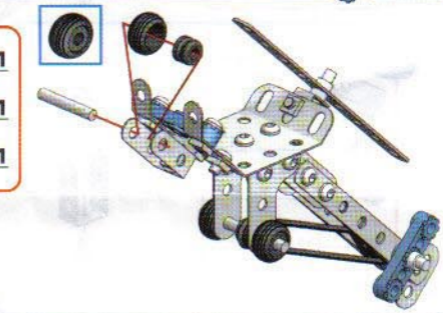

- 12**
-  25 mm | 1" x1
 -  x1
 -  x1

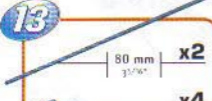

- 13**
-  80 mm | 3 1/8" x2
 -  x4
 -  x4

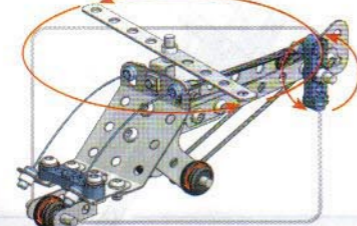
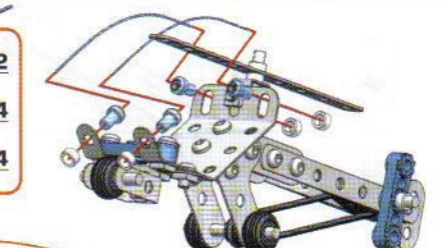

- GB** Many of the models and component parts are unique and original designs which are the property of MECCANO S.A. They are protected by national legislation as industrial designs, trademarks and/or copyrights throughout many countries. For detailed information, please contact MECCANO S.A. MECCANO S.A. accepts no responsibility for: (1) use for any purpose other than as specified in the instructions; (2) any alteration of any parts or components.
- F** De nombreux modèles et pièces sont des créations originales, propriété de MECCANO S.A. et sont protégés par les législations nationales sur les dessins et modèles, marques et/ou droits d'auteurs. Pour toute information, merci de contacter: MECCANO S.A. La responsabilité de MECCANO S.A. ne saurait être engagée en cas d'accident survenu à la suite (1) de non respect des instructions de montage; (2) d'une utilisation des pièces autre que celle proposée dans le manuel; (3) d'une altération ou de la modification des pièces.
- D** Zahlreiche Modelle und Teile sind Erfindungen und Eigentum der Firma MECCANO S.A. Sie sind durch Patentrecht, Marken- und/oder Urheberrechte geschützt. Für zusätzliche Auskünfte wenden Sie sich bitte an: MECCANO S.A. Die Firma MECCANO S.A. haftet nicht für Unfälle, die aus der (1) Nichtbefolgung der Bauanleitung, der (2) Verwendung anderer als in der Bauanleitung angegebenen Teile oder der (3) Änderung oder Modifikation der Teile resultieren.
- I** Numerosi modelli e pezzi sono creazioni originali della MECCANO S.A. e sono protetti dalle legislazioni nazionali sui disegni a modelli, marchi e/o diritti d'autore. Per qualsiasi informazione, vogliate prendere contatto con: MECCANO S.A. MECCANO S.A. accetta ogni responsabilità in caso di infortunio sopravvenuto in seguito a: (1) non rispetto delle istruzioni di montaggio; (2) utilizzo dei pezzi per funzioni diverse da quelle previste nel manuale; (3) alterazione o modifica dei pezzi.
- E** Numerosos modelos y piezas son creaciones originales, propiedad de MECCANO S.A. y están protegidos por las legislaciones nacionales en lo que concierne a los dibujos y modelos, marcas y/o derechos de autor. Para cualquier información, sírvase ponerse en contacto con: MECCANO S.A. MECCANO S.A. acepta de responsabilidad en caso de accidente debido a: (1) el incumplimiento de las instrucciones de montaje; (2) una utilización de las piezas diferente a la que se indica en las instrucciones; (3) una alteración o modificación de las piezas.
- P** Vários modelos e peças são criações originais, propriedades da MECCANO S.A. e são protegidos pelas legislações nacionais relativas aos desenhos e modelos, às marcas e/ou aos direitos de autor. Para qualquer informação, é favor contactar: MECCANO S.A. A Sociedade MECCANO S.A. não poderá ser responsabilizada pelos acidentes provocados: (1) pela falta de cumprimento das instruções de montagem; (2) pelo uso indevido das peças ou (3) pela modificação ou alteração das peças.
- S** Många modeller och delar bildar en unik och original föremållar vilken är MECCANO S.A. egendom. Dessa modeller och delar är skyddade genom lagstiftning såsom industriell föremållar, varumärkte och/eller upphovsrättigheter i ett flertal länder. För mer detaljerad information, var vänlig och kontakta MECCANO S.A. MECCANO S.A. åtar sig inte ansvar i händelse av olycka till följd av (1) att monteringsinstruktionerna inte har respekterats (2) en annan användning av delarna än den som står i anvisningen (3) en förändring eller förändring av delarna.

- FR** Viele Modelle und Bauteile sind originale Erfindungen und Eigentum der MECCANO S.A. Zeichnungen, Modelle, Marken und/oder Urheberrechte sind geschützt durch das nationale Recht in vielen Ländern. Für weitere Informationen wenden Sie sich bitte an: MECCANO S.A. MECCANO S.A. übernimmt keine Verantwortung für: (1) die Verwendung der Modelle für andere Zwecke als die in den Bauanleitungen angegeben; (2) die Verwendung von Teilen oder Komponenten, die nicht in den Bauanleitungen angegeben sind; (3) die Änderung oder Modifikation der Teile.
- DK** Udsæt model til brug ved MECCANO S.A. er beskyttet af de danske lovgivningsmyndigheder. Udsæt model til brug ved MECCANO S.A. er beskyttet af de danske lovgivningsmyndigheder. Udsæt model til brug ved MECCANO S.A. er beskyttet af de danske lovgivningsmyndigheder. Udsæt model til brug ved MECCANO S.A. er beskyttet af de danske lovgivningsmyndigheder.
- NL** Veel modellen en onderdelen zijn originele ontwerpen en eigendom van MECCANO S.A. en worden beschermd door de nationale wetgeving op tekeningen en modellen, merken en/of auteursrechten. Voor informatie gelieve contact op te nemen met MECCANO S.A. De verantwoordelijkheid bij het gebruik van de montage-instructies (1), of het gebruik van andere onderdelen dan die zoals vermeld in de handleiding (2) of het aanbrengen of modificeren van de onderdelen (3).
- GR** Πολλά πρότυπα και εξαρτήματα είναι υλικών, ιδιοκτησίας της MECCANO S.A. και προστατεύονται από τις εθνικές νομοθεσίες σχετικά με σχέδια, εμπορικά σήματα και/ή δικαιώματα πνευματικής ιδιοκτησίας. Για περισσότερες πληροφορίες, παρακαλούμε επικοινωνήστε με: MECCANO S.A. Η MECCANO S.A. δε φέρει καμία ευθύνη για: (1) την χρήση των εξαρτημάτων για σκοπούς διαφορετικούς από αυτούς που προβλέπονται στις οδηγίες; (2) την χρήση άλλων εξαρτημάτων από αυτά που προβλέπονται στις οδηγίες; (3) την αλλαγή ή τροποποίηση των εξαρτημάτων.
- JPH** 多くのモデルと部品は、MECCANO S.A.の独自の設計であり、MECCANO S.A.の財産です。これらのモデルと部品は、特許権、商標権、著作権、およびその他の権利によって保護されています。MECCANO S.A.は、(1)本製品の組立説明書に従わずに他の目的で使用されること、(2)組立説明書に記載されていない部品を使用すること、(3)部品の変更または改造を行うことについて、いかなる責任も負いません。
- USA** Many models and component parts are copyrighted original designs which are the property of MECCANO S.A. and are protected as design and/or utility patent and/or copyrights. For detailed information, please contact MECCANO S.A. Instruction booklets are solely for construction of sets. MECCANO S.A. shall have no responsibility for: 1. Failure to follow instructions. 2. Use of parts for any purpose other than as specified in the instruction booklets. 3. Any alteration of any parts or components.

Made in France by
Fischel et Fournier
MECCANO S.A. MECCANO is an exclusive trademark of MECCANO S.A.
© 1978 Meccano S.A.



MECCANO
363, Avenue de Saint-Exupéry
F - 62100 CALAIS